

MTD LN 175 H OPERATING INSTRUCTIONS MANUAL



Quick Links

[Operating Instructions](#)

[Assembly](#)

[Fill up with Fuel and Check the Oil Level](#)

[Maintenance](#)

[Engine Information](#)

Table of Contents

Operating instructions

Contents

Safety

General notes on safety

When working with the mower

Safety devices

Deflector/grass catcher

Symbols

Assembly

Location details

Disposal

Installing the seat

Attaching the grass catcher

Controls and indicators

Ignition lock

If an unfilled battery is supplied

Choke

PTO Lever

Cutting height adjustment lever

Brake pedal

Operation

Gear release lever for units with automatic drive

Transmission release for machines with a hydrostatic

Light

Fill up with fuel and check the oil level

Check tyre pressure

Adjusting the driver's seat

Starting the engine

Stopping the engine

Driving

Driving with the hydrostatic drive

Mowing

Transporting

Cleaning/servicing

Mulching

Emptying the grass catcher

Cutters with cleaning nozzle

Using jump leads

Maintenance

Tyre pressure

Engine information

Troubleshooting

Replacing fuses

Once a season

Other ManualsLib Projects

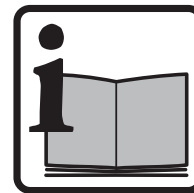

A16
FORM NO. 769-01812I

MTD Products Aktiengesellschaft • Saarbrücken • Germany



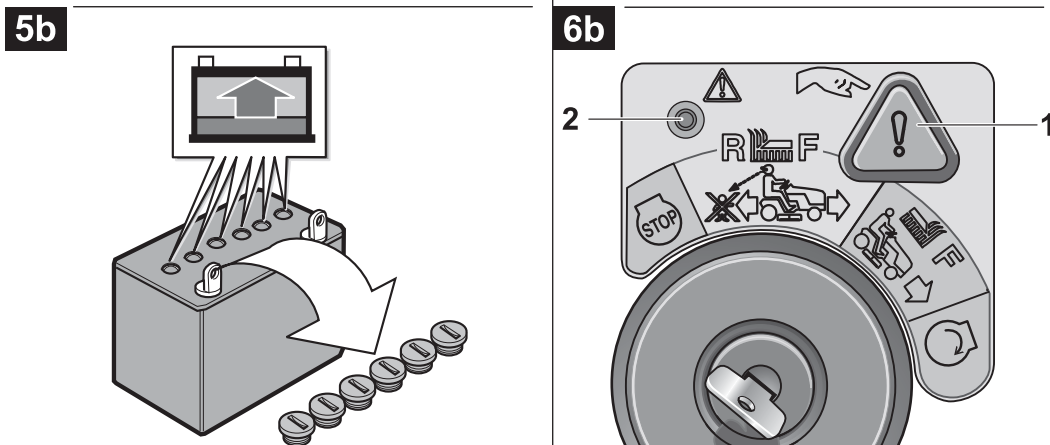
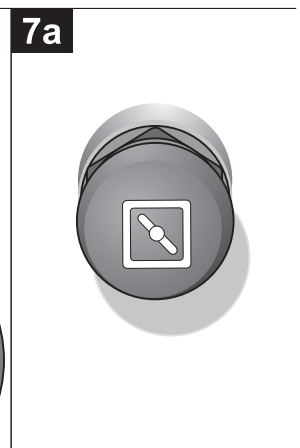
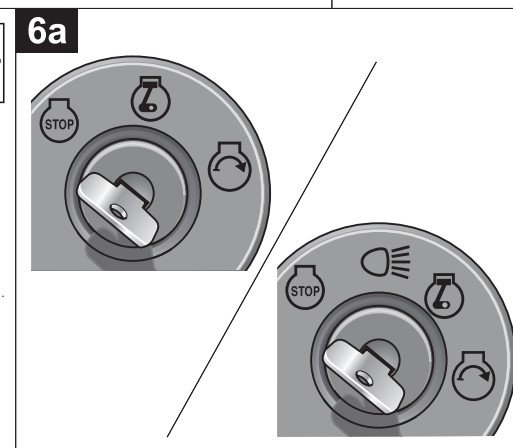
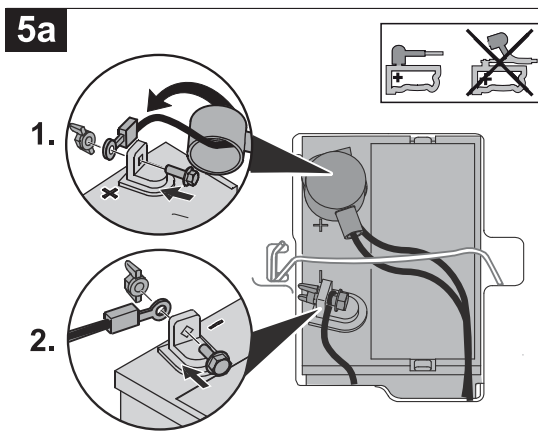
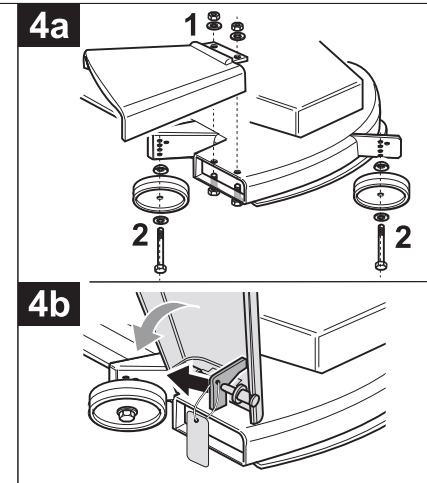
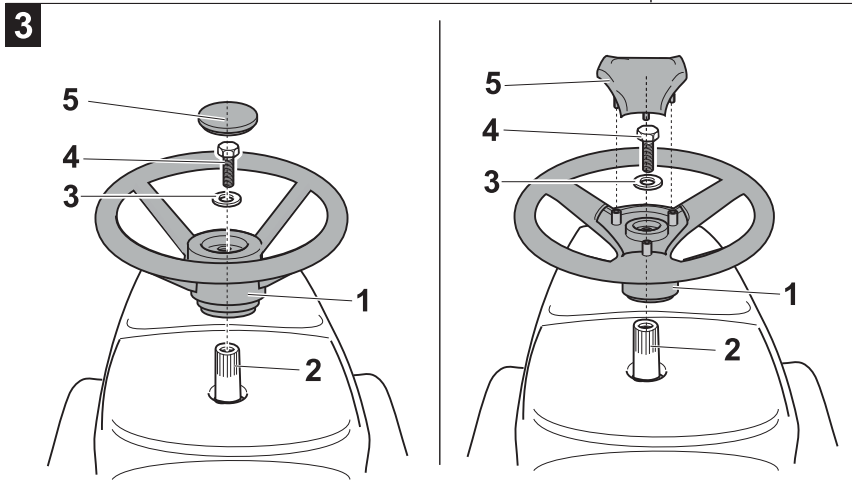
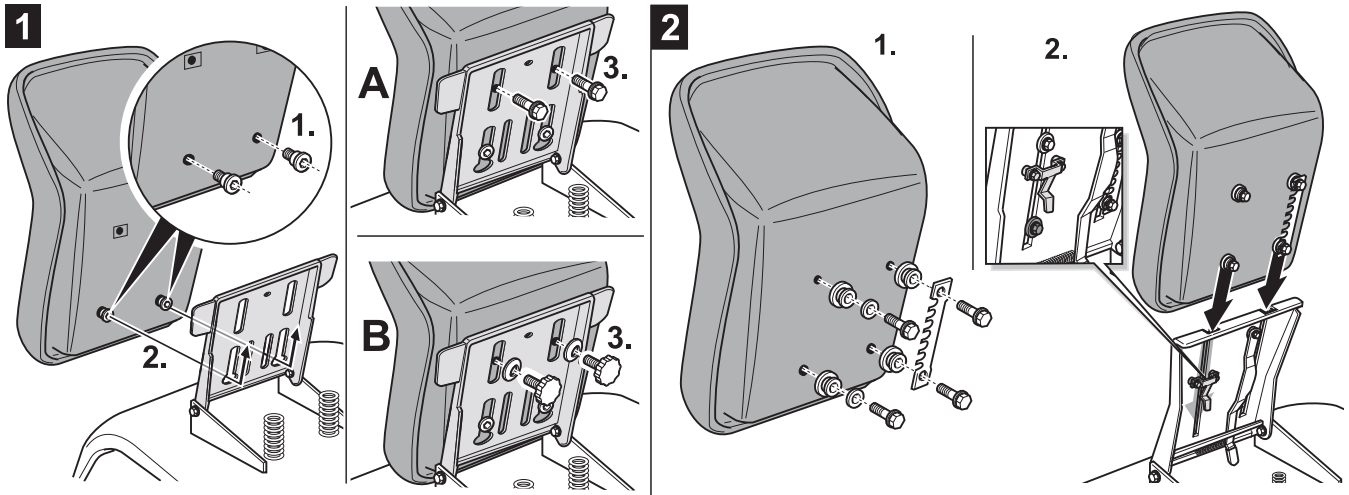

8

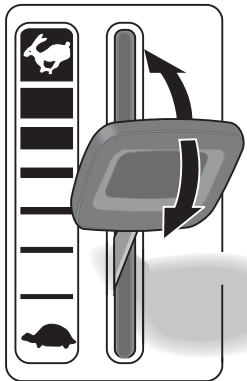

9

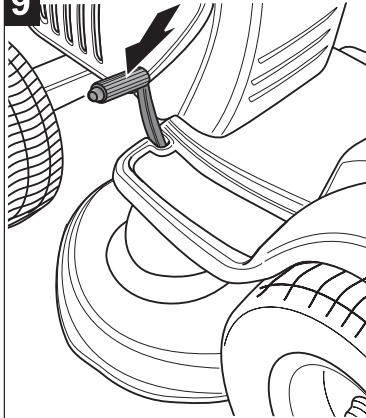

10

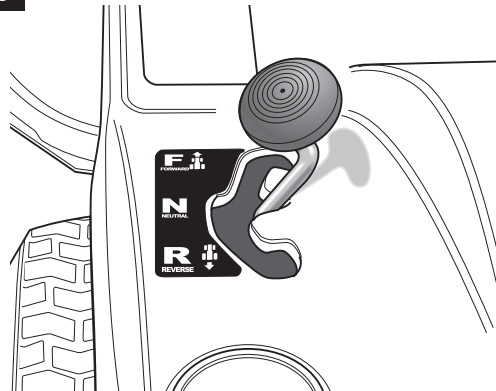

11

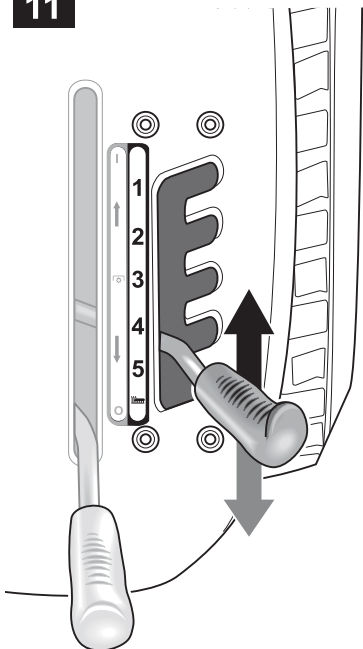

12

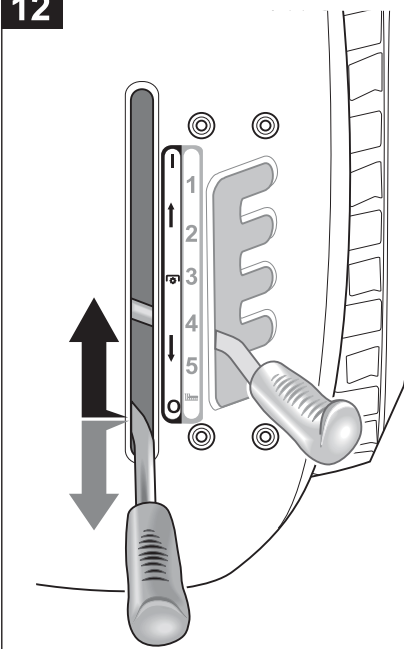

13

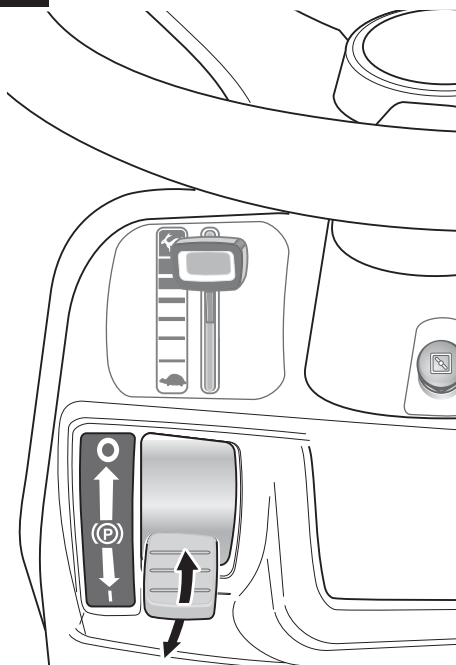

14

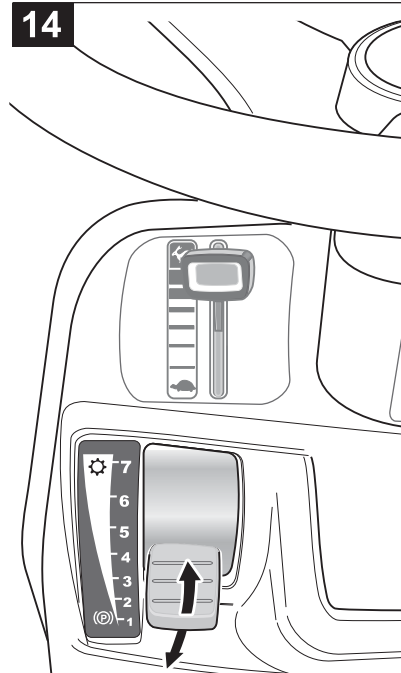

15

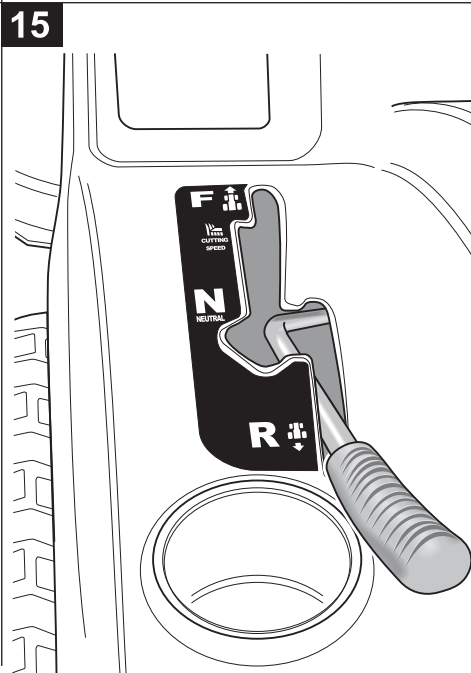

16

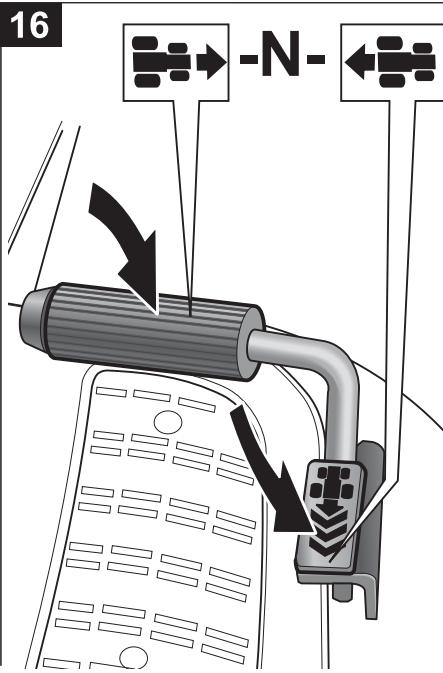

17

a

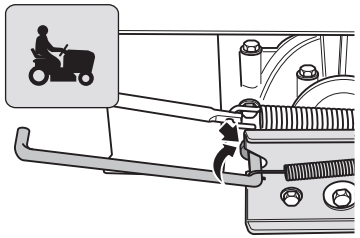
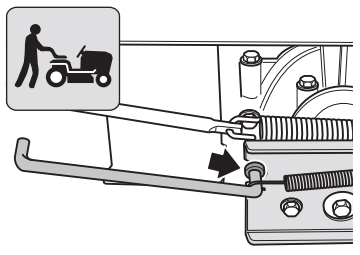

b

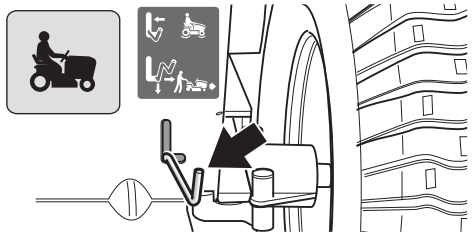
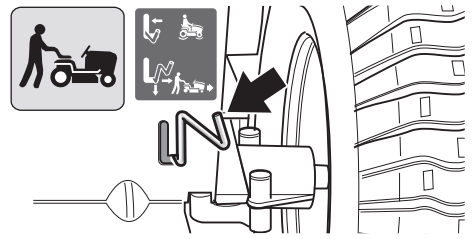

c

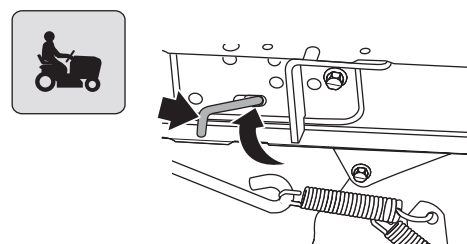
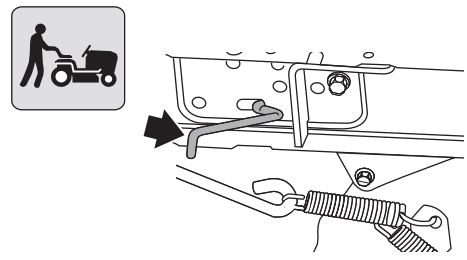

18

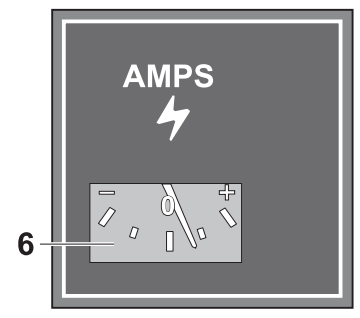
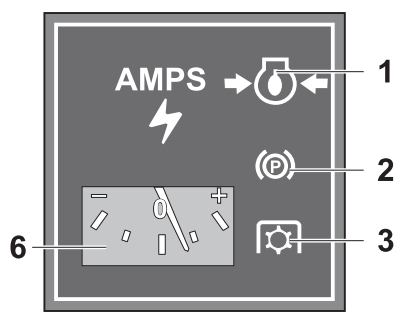
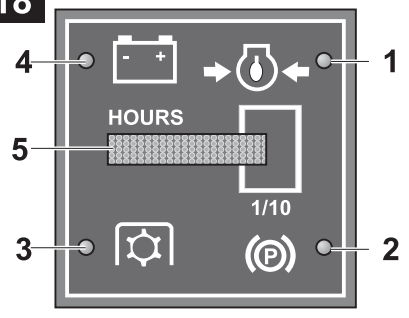

19

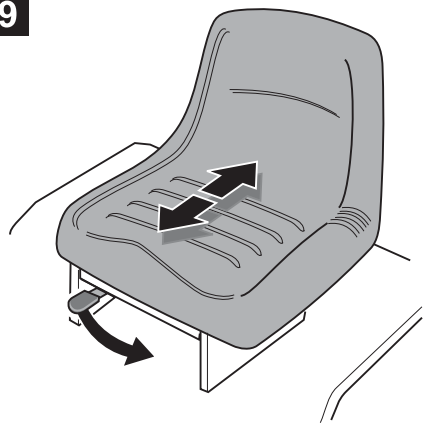

20

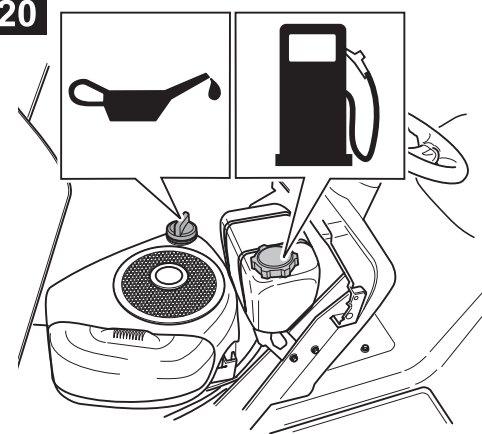

21



22

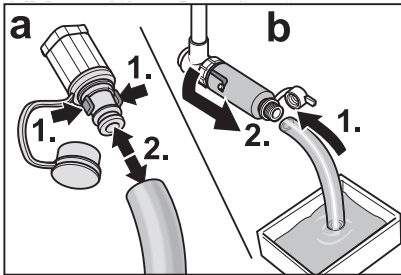
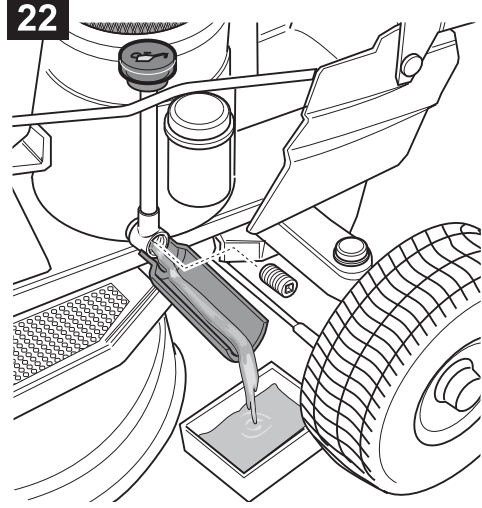

23

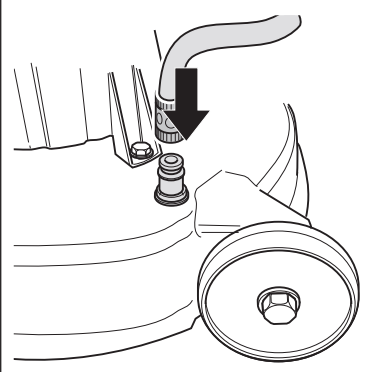



English (Original operating instructions)	→	
Français (Notice d'instructions d'origine)	→	
Deutsch (Originalbetriebsanleitung)	→	
Nederlands (Originele gebruiksaanwijzing)	→	
Italiano (Istruzioni per l'uso originali)	→	
Español (Instrucciones de funcionamiento originales)	→	
Svenska (Originalbruksanvisning)	→	
Dansk (Originale driftsvejledning)	→	
Norsk (Originale driftsanvisningen)	→	
Suomi (Alkuperäinen käyttöohjekirja)	→	
Português (Instruções de serviço originais)	→	
Ελληνικά (Αυθεντικές οδηγίες χειρισμού)	→	
Magyar (Eredeti üzemeltetési útmutató)	→	
Polski (Oryginalna instrukcja obsługi)	→	

Contents

For your safety 8
 Assembly 10
 Controls and indicators 11
 Operation 13
 Tips on lawn care 16
 Transporting 16
 Cleaning/servicing 16
 Shutting down the unit 18
 Warranty 18
 Engine information 18
 Troubleshooting 18

Information on the identification plate

These details are very important as they will not only be needed for identifying your mower when ordering replacement parts but they will also be required by Customer Service. You will find the rating plate under/in front of the driver’s seat. Enter all the details on your mower’s rating plate in the following fields.

This and other appliance information can be found on the separate CE declaration of conformity which is a component of these operating instructions.

The model number identification

The fifth digit of the model number specifies the Series, Example:
 Model number:
 13BT793G678 = means a model of the 700 Series.

Illustrations



Fold out the illustrated pages at the start of the operating manual. Various models are described in these operating instructions.

The illustrations may differ in detail from the machine which you have purchased.

For your safety

Use the mower properly

- This mower is designed to be used
- as a lawn tractor for mowing lawns of domestic and leisure gardens,
 - with accessories which are expressly permitted for use with this lawn tractor,
 - in accordance with the descriptions and safety instructions given in these operating instructions.

Any other use is not an intended use. Improper use is not covered by the warranty and the manufacturer will reject any liability. The user is liable for any injuries to third parties and/or damage to their property.

Unauthorised changes to the mower exclude liability of the manufacturer for any resulting damage and/or injury.

This mower is not licensed for use on public roads or for transporting people.

General notes on safety

Before you use this mower for the first time, carefully read these operating instructions and act accordingly.

Inform other users how to operate the machine properly. Operate the mower only in the technical condition in which it has been provided and delivered by the manufacturer.

Keep these operating instructions in a safe place where they are readily available whenever the machine is used.

If the mower changes ownership, hand over the operating instructions with the mower.

Spare parts and accessories must satisfy the requirements specified by the manufacturer.

Therefore use original spare parts and original accessories only or spare parts and accessories authorised by the manufacturer.

Arrange for repair work to be carried out by a specialist workshop only.

Before working with the mower

Do not use the mower if you are tired or ill.

Any person intending to use this machine must not be under the influence of intoxicants such as alcohol, drugs or medicines. Do not permit children under the age of 16 to handle this machine (local regulations may specify the minimum age of the user).

This appliance is not intended for use by persons (including children) with reduced physical, sensory or mental capabilities, or lack of experience and knowledge, unless they have been given supervision or instruction concerning use of the appliance by a person responsible for their safety.

Children should be supervised to ensure that they do not play with the mower.

Before you begin work, make sure that you are familiar with all attachments and operating controls as well as their functions.

Store fuel in approved containers only and never close to sources of heat (e.g. heaters, stoves or hot-water boilers).

Replace the exhaust unit, tank or fuel cap if they become damaged.

Observe guidelines when connecting towed items or attachments to the mower. Driving performance, especially steering, braking capability, and overall stability are affected by attachments, towed items, ballast weights and the weight of a grass catcher when full.

When working with the mower

When working with or on the mower, wear appropriate work clothes (e.g. safety boots, long trousers, tight-fitting clothing, goggles and hearing protection).

Working without ear protection may result in loss of hearing.

Do not operate the mower unless it is in perfect and safe working order.

Never change the pre-set factory engine settings.

Do not refill the fuel tank while the engine is running or if it is still hot. Only refuel the mower outside.

Avoid open fire, formation of sparks, and do not smoke.

Make sure that at all times there are no persons, especially children, or animals in the working area.

Check the terrain on which the mower is to be used and remove all objects which could be thrown out by the mower. This will avoid endangering people and damaging the mower.

Do not mow on slopes with an incline greater than 20%. Working on slopes is dangerous; the mower may overturn or slip.

Start off slowly and brake gently on slopes. Keep the clutch engaged and proceed slowly when driving downhill. Do not travel across the face of a slope; always drive straight up and down.

Operate this mower only in daylight or good artificial light.

The mower is not licensed for transporting people.

Do not carry passengers.

Do not travel with the bonnet open.

Before carrying out any work on the mower

Protect yourself against injury. Before carrying out any work on this mower

- switch off the engine,
- withdraw the ignition key,
- lock the parking brake.
- Wait until all moving parts have come to a standstill; the engine must have cooled down,

- Pull off the spark plug connector so that the engine cannot inadvertently start.

After working with the mower

Do not leave the mower unattended until you have turned off the engine, applied the parking brake and removed the ignition key.

Safety devices

Safety devices are provided for your protection and must always function properly.

You must not modify safety devices in any way or bypass their function.

Safety features are:

Deflector/grass catcher

The deflector (Fig.4)/grass catcher protects you from injury that can be inflicted by the cutters or solid objects flung out by the appliance. The lawn tractor should never be operated with the deflector/grass catcher detached.

Safety interlock system

The safety interlock system will only allow the engine to start when

- the driver is sitting on the seat,
- the brake pedal has been depressed or the parking brake is in the park position,
- the direction lever or the accelerator pedal is at "N",
- the cutter deck is switched off, i. e.: PTO switch or PTO lever set to "0/Off" (PTO = Power-Take-Off).

The safety interlock system switches the engine off as soon as the operator leaves his seat without actuating the parking brake or switching off the cutter deck.













The safety interlock system prevents rear discharge units from mowing without attached deflector/grass catcher (automatic disconnection of engine or cutter deck).

If units have no OCR function or the OCR function is deactivated, the safety interlock system prevents the unit from reversing while the cutter deck is switched on (automatic disconnection of engine or cutter deck).

Before reversing appliances with PTO, therefore, switch OFF the cutters at the PTO switch or PTO lever.

Symbols on the mower

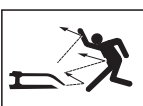
On the mower you will find various symbols on adhesive labels. They have the following meanings:

	Caution! Before switching on the unit, read the operating instructions!
	
	
	Keep third parties out of the danger area!
	
	
	Injury hazard due to rotating blades or other moving parts.
	Keep hands and feet out of the openings when the machine is running.
	
	Injury hazard due to rotating blades or other moving parts.
	Injury hazard due to grass or solid objects thrown out by mower.
	Working on steep slopes can be dangerous.

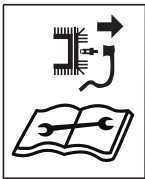

Before working on the cutters, remove the spark-plug connector! Keep fingers and feet away from the cutters!

Always switch off the appliance and remove the spark plug connector before adjusting, cleaning or checking it.



Caution! Danger of explosion.



Battery acid/risk of chemical burns.



Wear protective gloves.



No fires, sparks, naked flames or smoking.

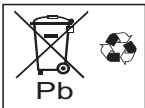

Old batteries must not be disposed of with domestic waste.

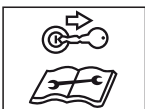

Before beginning any work on this mower, remove the ignition key and observe all information contained in these instructions.



When getting on and off, never step on the cutter deck.



Beware of hot surface!

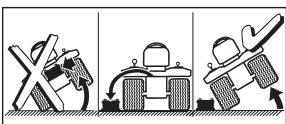

Before tipping the device, remove the battery.

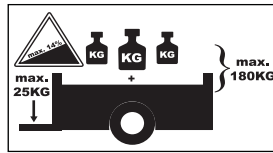

If operating with an attached trailer, do not exceed the following maximum values:

- Max. gradient 14%
- Max. support load on the trailer coupling 25 kg
- Max. trailer load (trailer and load) 180 kg



The unit may be operated with the attached discharge flap or the mulch locking part only.

Ensure these symbols mounted on the mower remain legible.

Replace damaged or illegible symbols.

Symbols in the operating instructions

The following symbols are used in these operating instructions:



Danger
Draws your attention to sources of potential danger associated with the task you are undertaking at the time which constitute a danger to persons.



Caution
Draws your attention to potential hazards associated with the task you are undertaking at the time which could result in damage to the mower.



Note
This indicates important information and application tips.

Location details

Where a position on, or in relation to, the unit is described (e.g. left, right), this is always from the perspective of the driver, sitting on the driver seat and facing forward.

Disposal instructions

Dispose of packaging remnants, old mowers, etc., in accordance with local regulations.

Assembly

Installing the seat

Seat without adjusting lever:

Figure 1

Seat with adjusting lever:

Figure 2

Installing the steering wheel

Fig. 3

- Connect steering wheel (1) to steering shaft (2).
- Put on washers (3) and secure steering wheel with bolt (4).

i Note

Put on washer (3) with curved side face up.

- Insert cover cap (5, depending on model).

Installing the deflector

(Appliances with side ejector)

Fig. 4a

- Remove all screws, washers, and nuts on the deflector.
- Insert the deflector (1), and secure it with the screws, washers, and nuts.
- Secure the cutter rollers (2) with the available screws, washers, and nuts.

Fig. 4b

The deflector and cutter rollers are now installed.

- Press the deflector back slightly, and remove the securing plate. The deflector closes automatically.

Attaching the grass catcher (depending on model)

- See the separate operating instructions for the grass catcher.

Preparing the battery

Figure 5

Danger

Risk of poisoning and injury from battery acid

Wear safety goggles and protective gloves. Do not allow battery acid to come into contact with skin. If you get battery acid on your face or in your eyes, wash off immediately with cold water and consult a doctor.

If you accidentally swallow battery acid, drink plenty of water and consult a doctor immediately.

Store batteries out of the reach of children.

Never tilt the battery, as battery acid may run out.

Bring the remaining, unused battery acid to your dealer or to a waste disposal company.

Caution

Risk of fire, explosion and corrosion caused by battery acid and gases emitted by battery acid
Immediately clean parts of the unit splashed by battery acid. Battery acid is corrosive.

Do not smoke, keep burning and hot objects away. Charge batteries in a well ventilated and dry room only. There is a risk of a possible short circuit when working with the battery. Do not place any tools or metal objects on the battery.

Caution

Disconnect and connect the battery in the correct sequence. Only operate the battery with the battery terminal cover fitted (depending on the model, as a cover flap on the positive terminal or a complete protective battery cover).

Installation (fig. 5a):

- First connect the red cable (+/positive pole) and then the black cable (-/negative pole).
- Fit the battery terminal cover.

Removal:

- Remove the battery terminal cover.
- First disconnect the black cable (-/negative pole) and then the red cable (+/positive pole).

Note

The battery is situated under the passenger seat.

If a “maintenance-free/sealed” battery is supplied (Type 1)

(Battery without filler plugs)

The battery is filled with battery acid and sealed at the factory. But even a “maintenance-free” battery needs servicing to ensure it has a certain service life.

- Keep the battery clean.
- Avoid tilting the battery. Electrolyte liquid will run out of even a “sealed” battery if it is tilted.
- Before using the mower for the first time, charge the battery with a battery charger (maximum charging current 12 volts, 6 amps) for 1–2 hours. After charging the battery, first pull out the battery charger plug, then disconnect the battery (see also operating instructions for the battery charger).

If an unfilled battery is supplied (Type 2)

(battery with sealing plugs)

- Remove sealing plugs from the battery cells (Fig. 5b).
- Slowly fill each cell with battery acid up to 1 cm below the filling orifice.
- Leave battery to stand for 30 minutes so that the lead can absorb the battery acid.
- Check the acid level and, if required, top up the battery acid.
- Before using the mower for the first time, charge the battery with a battery charger (maximum charging current 12 volts, 6 amps) for 2–6 hours. After charging the battery, first pull out the battery charger plug, then disconnect the battery (see also operating instructions for the battery charger).

- Fit the battery cell plugs.
- Install battery in the appliance.
- First connect the red cable (+), then the black cable (-).
- Top up the battery with distilled water only (check every 2 months).
- Keep the battery clean.



Controls and indicators

Caution. Damage to the mower.

This first describes the control and display functions. Do not execute any of these functions yet!

Ignition lock (depending on model)

Fig. 6a

Starting: Turn key to the right  until the engine is running, then release. Key is turned to .

Stopping: Turn the key to the left, to .



Note

If the ignition lock features a light position , the light is switched on when the ignition key is moved back to this position when the engine has started.

Ignition lock with OCR function (depending on model)

Fig. 6b

This ignition lock features an OCR function (= user-controlled mowing in reverse gear).

Starting: Turn key to the right  until the engine is running, then release. The key at  (normal) allows mowing in the drive direction.

OCR position: Turn key to left of normal position to reverse mowing position  and press the switch (1).

The indicator light (2) comes on and indicates to the user that the unit can now mow in reverse and forward gear.

Stopping: Turn the key to the left, to .

i Note

Do not use the OCR function unless absolutely necessary, otherwise work with the key in the normal position. The OCR function switches off automatically as soon as the key is turned to the normal position or the engine is switched off (stop position or disconnection of the engine by the safety interlock system).

Choke (depending on model)

Fig. 7

To start a cold engine, pull the choke (Fig. 7a), or move the accelerator lever to  (Fig. 7b).

Throttle

Fig. 8

Set engine speed continuously.

Fast engine speed = .

Slow engine speed = .

Clutch/brake pedal (only for models with Transmatic drive)

Fig. 9

Clutching = Depress pedal half way.

Braking = Depress pedal all the way.

i Note

Is also used to activate/deactivate the parking brake.

Brake pedal

Fig. 9

Brake = Depress pedal.

i Note

Is also used to activate/deactivate the parking brake.

Direction-of-travel lever (only models with Transmatic drive)

Figure 10

The direction lever must be used only when the tractor is stationary.

To do this, depress the clutch/brake pedal all the way and keep depressed.

Forwards = Lever to "F/

Idling = Lever to "N"

Reverse = Lever to "R/

Cutting height adjustment lever

Figure 11

Largest cutting height, cutters top = lever to "5 (H)".

Smallest cutting height, cutters bottom = lever to "1 (L)".

PTO lever

Figure 12

The PTO lever mechanically switches the cutter deck on and off.

Switch off cutter deck 0 /  = pull lever all the way backwards

Switch on the cutter deck 1 /  = slowly push the lever forwards to the stop

Parking brake for units with hydrostatic drive / automatic drive

Figure 13

Actuate the parking brake: Fully depress brake pedal and move lever to position "1".

Release the parking brake: Depress the brake pedal all the way and move the lever to the "0" position.

Lever for speed settings/ parking brake for units with Transmatic drive

Fig. 14

Low speed = Lever on "1".

High speed = Lever on "6" or "7" (optional).

Increase speed = Adjust drive positions without actuating the clutch/brake pedal.

Reduce speed = Adjust drive positions by actuating the clutch/brake pedal (depress halfway).

Actuate the parking brake: Fully depress clutch/brake pedal, push lever for speed setting to .

Release the parking brake: Fully depress clutch/brake pedal, push lever to a speed setting.

Drive lever for units with hydrostatic drive (depending on model)

Fig. 15

Using the drive lever, set the speed steplessly and change the driving direction.

Forwards:

Fast forward driving = Lever to "F/.

Maximum mowing speed = Lever to  "CUTTING SPEED / .

Stopping:

To stop driving and change direction = lever to "N".

Backwards:

Reverse driving = lever to "R/.

i Note

- The further the lever is pressed towards "R" or "F", the faster the unit moves.
- When the brake pedal is actuated and released again, the drive lever moves towards the "N" position and reduces the operating speed.

Accelerator for units with hydrostatic drive (depending on model)/automatic drive

Fig. 16

The drive pedal is used to adjust the speed continuously and to change direction:

Forwards = push forwards the accelerator pedal (in direction , the further forward, the faster.

Stop (for stationary vehicle and changing direction) = release the drive pedal (N).

Reverse = push back the accelerator pedal (counter to direction , the further back, the faster.

i Note

When the parking brake is applied, the accelerator cannot be actuated.

Gear release lever for units with automatic drive

Fig. 17a

The lever is situated on the left side of the unit between the footboard and rear wheel.

To push the mower when the engine is switched off:

- Press lever inwards, then pull outwards and swivel to the rear. The lever is engaged in front of the holder.

To drive:

- Push the lever to the left and press in.

Transmission release for machines with a hydrostatic drive

Units with drive lever

Fig. 17b

The lever is situated on the rear panel of the machine.

To push the mower when the engine is switched off:

- Pull out lever and press to the right.

To drive:

- Push the lever to the left and press in.

Units with accelerator

Fig. 17c

The lever is situated on the left side of the unit between the footboard and rear wheel.

To push the mower when the engine is switched off:

- Pull out lever and press to the right.

To drive:

- Push the lever to the left and press in.

Combination indicator (depending on model)

Fig. 18

According to the model, the combination indicator can consist of the following elements.

Oil pressure (1):

The indicator light is lit while the engine is running, immediately switch off engine and check oil level. Where necessary, visit a garage.

Clutch (2):

Indicator light comes on if the clutch/brake pedal is not depressed or the parking brake is not engaged when the engine starts.

Cutter deck (3):

The indicator lamp lights up when the cutters are not switched OFF at engine start.

Battery charge indicator (4):

If the indicator light lights up when the engine is running, this means that the battery is not sufficiently charged.

Where necessary, visit a garage.

Operating hour counter (5):

This shows the elapsed engine hours when ignition is on.

Ampere meter (6):

This shows the charging current from the generator to the battery.

Slow engine speed
= needle at the centre.

Fast engine speed
= needle always on the right (+).

Optional functions:

- When the ignition is switched on, the battery voltage indicator is indicated for a short period and then the operating hours are indicated.

The operating hours are always counted except for when the ignition key is in the "Stop" position or when it is removed.

- Each time 50 operating hours have elapsed (according to the model), the oil change indicator "CHG/OIL" appears in the display for five minutes.

This message appears after the next two hours of operation. See the engine manual for oil change intervals.

Light (depending on model)

Fig. 21

Switch on headlights

= Set switch to "ON".

Some models do not feature the light switch.

The headlights are lit as long as the engine is running or the ignition key is set to the  position (depending on model).

Seat with adjusting lever (depending on model)

Fig. 19

Pull the lever, and adjust the seat.

Operation

Follow the instructions in the engine handbook!

Danger

Risk of injury

No person, especially children, and/or animals should be allowed to stand close to the mower while it is in use.

They could be injured by stones or similar objects that might be thrown out. Children must never be allowed to operate the mower.

Be particularly careful when mowing in reverse gear (mowers with OCR switch).

There must be nobody in the working area of the unit.

Never empty the grass catcher attachment while the cutter deck is running. While emptying the grass catcher attachment, you or other persons may be injured by ejected clippings.

Take extra care with opening and closing the grass catcher; there is a risk of crushing.

When mowing on steep slopes, there is a risk of the mower tipping over and you could be injured as a result.

Do not drive across the face of a slope, but only straight up and down. The mower should not be driven on slopes with a maximum incline greater than 20%. Do not turn the mower round while you are still on the slope.

If the ground is wet the mower could slip due to reduced traction and overturn. Only cut the grass when the ground is dry.

Excessive speed can increase the risk of an accident.

When mowing closed to the lawn edges, maintain a safe distance at all times e.g. close to particularly steep slopes, trees, bushes and hedges.

Pay particular attention when you are travelling in reverse while mowing at the same time.

Inspect the ground on which the mower is going to be used and remove any loose objects that could be picked up and thrown out again by the mower.

If the cutter strikes a foreign object (e.g. stone) or if the mower starts vibrating unusually: Immediately switch off the engine. Before continuing to use the mower, have it checked for damage by a specialist workshop.

When rotary mowing, never stand in front of the grass discharge openings.

Never place your hands or feet on or under rotating parts.

Switch off the engine and remove the ignition key and the spark-plug connector before loosening obstructions or removing blockages from the discharge channel. Do not use the mower in adverse weather conditions, e.g. if there is a risk of rain or a storm.

Danger of carbon monoxide asphyxiation

Run the internal combustion engine outdoors only.

Danger of explosion and risk of fire
Petrol vapour is explosive and petrol itself is extremely flammable.

Fill up with petrol before you start the engine.

Do not remove the fuel cap while the engine is running or if it is still hot.

Fill the fuel tank only after the engine has been switched off and allowed to cool down. Prevent naked flames, formation of sparks, and do not smoke. Only refuel the mower outside.

Do not start the engine if any petrol has been spilt. Push the mower away from the area where the petrol was spilt and wait until the petrol fumes have evaporated.

To prevent a fire hazard, keep the following parts free from grass and leaking oil: Engine, exhaust, battery, fuel tank.

⚠ Danger Injury hazard due to defective mower

Do not operate the mower if it is not in perfect working order.

Before operating the unit, always carry out a visual inspection. Pay particular attention to safety devices, the cutting mechanism and its supporting brackets, operating controls and threaded connections, and check that they are not damaged and are securely attached.

Replace damaged parts before operating.

**⚠ Danger
Risk of injury**
While the engine is running or hot, do not check, inspect or service/adjust the mower.

i Operating times

Comply with the national/municipal regulations concerning the times when the mower may be used (if required, contact your local authority).

Fill up with fuel and check the oil level

i Note

The engine has already been filled with oil at the factory – please check the oil, if required refill.

- Fill up with lead-free petrol (Fig.20).
- Fill fuel tank up to max. 2 cm below the lower edge of the inlet nozzle.

- Close fuel tank tightly.
- Check the oil level (Fig.20). The oil level must be between the “Full/Max.” and “Add/Min.” marks (see also engine handbook).

Check tyre pressure

i Note

For production reasons the tyre pressure may be higher than required.

- Check tyre pressure. If required, correct (see section “Maintenance”):
 - front: 0.8 bar
 - Rear: 0.7 bar

Adjusting the driver’s seat

- Move seat to the required position.

Depending on model:

- Loosen screws, adjust seat and retighten screws (Fig. 1)

or





- Pull seat adjusting lever, adjust seat and release seat adjusting lever again (Fig. 19).

Starting the engine

- Sit on the driver’s seat.
- Switch off the cutter deck: Switch off PTO (Fig. 12) and raise the cutter deck.
- Depress the brake pedal or clutch pedal all the way and hold (Fig. 9) or engage the parking brake (Fig.13/14).
- Move direction of travel lever (Fig.10/15) to “N”.

i Note

Units with accelerator are in the “N”-position unless the accelerator is depressed (Fig. 16).

- Set the throttle lever (Fig.8) to .
- To cold-start the engine, pull the choke or move the accelerator lever to  (Fig. 7).
- Turn the ignition key (Fig. 6) to  until the engine is running (attempt to start the engine for max. 5 seconds, wait 10 seconds before attempting to start the engine again). When the engine is running, set the ignition key to  /  F.

- Slowly push back the choke (Fig. 7).
- Return the accelerator lever (Fig.8) until the engine runs smoothly.

Stopping the engine

- Move the throttle (Fig.8) to the middle position.
- Leave the engine running for approx. 20 seconds.
- Turn the ignition key (Fig.6) to .
- Remove the ignition key.
- Engage the locking brake before leaving the appliance.

Driving

Danger

Abrupt starting, sudden stopping, and driving at an excessively high speed increases the risk of accidents and may damage the mower. Never set/adjust the driver's seat while the unit is moving.

Note

Be particularly careful when reversing. Never change the direction of travel without first bringing the unit to a standstill.

Driving with the hydrostatic drive

- Start the engine as indicated.
- Release the parking brake.
- Slowly actuate drive lever or accelerator (depending on model) until the required speed is reached.

Driving with the Transmatic drive

- Start the engine as indicated.
- Release the parking brake: Depress the clutch/brake pedal all the way and hold.
- Move the direction of travel lever to the corresponding position.
- Select speed setting with lever.
- Slowly release the clutch/brake pedal, the unit moves off.

Driving with automatic drive



- Start the engine as indicated.
- Release the parking brake.

- Slowly engage the accelerator pedal until you have reached the speed you want.

Stopping the mower

- Move drive lever to "N" position or release accelerator (units with hydrostatic drive/automatic drive).
- Step on the brake pedal or clutch/brake pedal until the unit stops.

Mowing

- In normal mowing mode  **F** (see Operation, ignition lock):
Before reversing the machine, switch off and raise the cutter deck.
- In reverse mowing mode  (see Operation, ignition lock):
Exercise extreme caution when reverse mowing and do not activate unless absolutely necessary.
- Do not change direction when the mower is coasting or driving.

Units with hydrostatic drive

- Start the engine as indicated.
- To ensure adequate power output, move the throttle to .
- Release the parking brake.
- Switch on the cutter deck.
- Lower the cutter deck.
- Using the drive lever or accelerator (depending on model) select forward direction of travel and speed (actuate slowly).
The mower starts moving.

Units with Transmatic drive

- Start the engine as indicated.
- To ensure adequate power output, move the throttle to .
- Release the parking brake: Depress the clutch/brake pedal all the way and hold.
- Move the direction-of-travel lever to "F"/forwards.
- Select speed setting with lever.
- Switch on the cutter deck:
 - Switch on PTO.
- Lower the cutter deck.
- Slowly release the clutch/brake pedal, the unit moves off.

Units with automatic drive

- Start the engine as indicated.
- To ensure adequate power output, move the throttle to .
- Release the parking brake.
- Switch on the cutter deck.
- Lower the cutter deck.
- Select forward drive and speed with the accelerator pedal (depress slowly). The mower starts moving.

General information

When adjusting the cutting height and travel speed, ensure that the mower is not overloaded.

Depending on the length, type, and dampness of the grass it may become necessary to adjust the cutting height and appliance speed for the optimum grass catcher performance.

If blockages occur, reduce the driving speed and increase the cutting height.

Switching off the mower

- Stop the mower.
- Switch off the cutter deck.
- Move the throttle to the middle position.
- Raise the cutters to the top.
- After 20 seconds set ignition key to .
- Remove the ignition key.
- Engage the locking brake before leaving the appliance.

Pushing appliances with hydrostatic drive

Push the mower only when the engine is switched OFF.

- Release the parking brake.
- Release transmission (Fig. 17b or 17c depending on model): Pull out lever and press to the right.

Return the gear lock lever before restarting the engine.

Pushing units with automatic drive

Push the mower only when the engine is switched OFF.

- Release the parking brake.

- Release the gear lock (Fig.17a): Press lever inwards, then pull outwards and swivel to the rear. The lever is engaged in front of the holder.

Return the gear lock lever before restarting the engine.

Mulching

Various appliances can also mulch when fitted with the corresponding accessories. Ask your specialised dealer for details.

Emptying the grass catcher (depending on model)

See the separate operating instructions for the grass catcher.

Tips on lawn care

Mowing

A lawn is made up of various different types of grass. If you mow your lawn frequently, those types of grass which form strong roots and a firm turf surface will grow better. If you seldom cut the grass, you will enhance the development of high-growing types of grass and other weeds, such as clover, daisies ...). The normal height of a lawn is approx. 4–5 cm. Only 1/3 of the total height should be mown; therefore cut 7–8 cm long grass to normal height.

Preferably do not cut the lawn shorter than 4 cm, otherwise the turf will be damaged in a dry period.

If the grass has grown particularly high (for example, during a holiday period), cut it back to its normal height in stages.

Mulching (using the accessories)

During mowing the grass is cut into small pieces (approx. 1 cm) and is left on the ground. A lot of the nutrients in the cut grass are retained for the benefit of the lawn.

For the best possible result the grass must always be kept short, see also section "Mowing".

Observe the following mulching instructions:

- Do not mow wet grass.
- Never mow more than max. 2 cm of the total grass length.
- Drive slowly.
- Use maximum engine speed.
- Regularly clean the cutter deck.

Transporting

If changing location, drive the lawn tractor short distances only. Transport the appliance on a vehicle over greater distances.

Note: The mower is not approved for public thoroughfares in accordance with national road legislation (StVO).

Short distances

Danger

Solid objects may be hit/propelled by the rotating cutter deck causing damage.

- Switch off the cutter deck before driving the mower.

Long distances

Caution

Damage in transit
The mode of transport used (e.g. transport vehicle, loading ramp) must be in accordance with guidelines (refer to the respective operating instructions). During transport the mower must be secured against slipping.

Environmental hazard due to leaked fuel

The mower must not be tilted when it is transported.

- Prepare a suitable transport vehicle.
- Attach the loading ramp to the vehicle.
- Manually push the unit at idling speed into the loading area (for units with hydrostatic drive or automatic drive release the gear).
- Lock the parking brake.
- Secure the power tool against slipping.

Cleaning/servicing

Danger

Injury hazard if engine is started inadvertently

Protect yourself against injury. Before carrying out any work on this mower

- Switch off the engine,
- Withdraw the ignition key,
- Lock the parking brake.
- Wait until all moving parts have come to a standstill; the engine must have cooled down,
- Remove the spark plug connector on the engine in order to prevent the engine from accidentally being started.

Cleaning

Caution

Do not clean the unit with a high-pressure cleaner.

Clean the unit

- If possible, clean the machine directly after mowing.
- Park the mower on firm and level ground.
- Move the direction-of-travel lever to position "F" or "R" (not available on all models).
- Lock the parking brake.

Note

When using the unit in winter, there is a particularly high risk of rust and corrosion. After use, always thoroughly clean the mower.

Cleaning the cutter deck

Danger

Injury hazard due to sharp cutting blades

Wear safety gloves.

If the unit has more than one cutting mechanism, moving one cutting mechanism may cause the other cutting mechanisms to move as well. Caution when cleaning the cutters.

⚠ Caution**Engine damage**

The mower must not be tilted to an angle greater than 30°. This might cause fuel to run into the combustion chamber and could lead to engine damage.

- Raise the cutter deck fully.
- Clean the cutting compartment with a scrubbing brush, hand brush or cloth.

Cutters with cleaning nozzle (optional)

Fig. 23

Place the mower on an even surface free of debris, stones, etc., and engage the locking brake.

1. Use a commercially available quick-release coupling to attach a water hose. Turn on water.
2. Start the engine.
3. Lower the cutter deck, and switch on for a few minutes.
4. Switch off the cutter deck and engine.
5. Remove the water hose.

Repeat steps 1 to 5 for the second cleaning nozzle (if provided).

At the end of cleaning (steps 1 to 5):

- Raise the cutters to the top.
- Start the engine, and switch on the cutter deck for a few minutes to dry it.

Cleaning the grass catcher**i Note**

See the separate operating instructions for the grass catcher.

- Remove and empty the grass catcher.
- The grass catcher can be cleaned with a powerful water jet, for example from a garden hose.
- Allow the grass catcher to dry off completely before using it again.

Maintenance

Observe the servicing instructions in the engine manual. At the end of the season have the mower inspected and serviced by a specialist workshop.

⚠ Caution**Engine oil is hazardous to the environment**

After changing the oil, take the waste oil to a waste oil collecting point or to a waste disposal company.

Batteries are an environmental hazard

Do not throw used batteries away with domestic waste.

Hand over used batteries to your dealer or to a waste management company. Remove the battery before scrapping the mower.

Using jump leads**⚠ Danger**

Never bridge a defective or frozen battery with jump leads.

Ensure that the machines and the jump lead clips do not touch that the ignitions are switched off.

- Connect the red jump lead to the positive terminal (+) of the flat battery and the donor battery.
- Connect the black jump lead first to the negative terminal (-) of the donor battery. Connect the other clip to the frame of the engine block of the tractor with the flat battery (as far away from the battery as possible).

i Note

If the donor battery is installed in a vehicle, this vehicle must not be started during the jump starting process.

- Start the tractor with the flat battery and actuate the parking brake.
- Disconnect the jump leads in reverse sequence.

Tyre pressure**⚠ Caution**

Never exceed the maximum permitted tyre pressure (see tyre wall). When pumping up the tyres, do not stand in front of or over the tyre.

The recommended operating tyre pressure is:

front:	0.8 bar
rear:	0.7 bar

Excessive tyre pressure reduces the service life of the tyres. Always check the tyre pressure before driving.

After 2–5 operating hours

- First engine oil change. See engine manual for subsequent intervals. Use the oil channel or (optional) quick oil drain (Fig. 22).

Every 25 operating hours

- Lubricate all rotating and bearing points (operating lever, height adjustment of the cutter deck, clutch/brake pedal, etc.) with several drops of light oil.
- Clean battery terminals.
- Lubricate all blade shafts, tensioning pulleys and tensioning pulley holders via the grease nipples using grease type 251H EP. Arrange for this work to be carried out by a specialist workshop.
- Apply multipurpose grease to the teeth on the steering gear.
- Lubricate the steering linkage with a few drops of light oil.
- Lubricate the wheel bearings and front wheel axes with a multipurpose grease applied to the grease nipples.

Every 2 months

- Only for battery type 2: Top up battery cells with distilled water up to 1 cm below the filling orifice.

Every 50 operating hours

- Dirt and grass remnants must be removed from the drive gear by a specialist workshop.

If required**Charge the battery**

If you are not using the unit for a prolonged period, it is recommended to take the battery out of the unit and charge it before storage, as well as every 2 months during storage, and before starting up the unit again.

i Note

Follow the instructions in the operating manual for your battery charger.

Replacing fuses

- Replace defective fuses only with ones of an equal rating.

Once a season

- Apply multipurpose grease to the teeth on the steering gear.
- Lubricate the steering linkage with a few drops of light oil.
- Lubricate all rotating and bearing points (operating lever, height adjustment of the cutter deck ...) with several drops of light oil.
- Clean the spark plug and check the gap between the electrodes or replace the plug. See engine handbook.
- The rear axles must be lubricated with a special-purpose (water-repellent) grease in a specialist workshop.
- The cutting blade must be sharpened or replaced by a specialist workshop.

Shutting down the unit



Caution

Material damage to the mower
Only store the mower once the engine has cooled in a clean and dry room or area. During prolonged storage, e.g. in winter, ensure that the mower is protected against rust. At the end of the season or when the vehicle will not be used for longer than a month:

- Clean the mower and grass catcher attachment.
- Wipe all metal parts with an oily rag or spray them with oil to protect them from rust.
- Charge battery with a battery charger.
- When shutting down the appliance for the winter, remove the battery, charge it and store in a dry/cool location (protected from frost). Charge the battery every 4–6 weeks as well as before re-installing it.
- Drain fuel (outdoors only) and shut down the engine as described in the engine manual.
- Inflate tyres according to the specifications on the tyre walls. If tyres have no specifications on the tyre walls, inflate to a pressure of 0.9 bar.
- Store the mower in a clean, dry room.

Warranty

The warranty terms issued by our company or importer are valid in every country.

Faults will be repaired free of charge within the framework of the guarantee, provided that they have been caused by a material defect or manufacturing error. Should you need to call upon the warranty, please apply to the vendor of your machine or to the nearest agency.

Engine information

The engine manufacturer is liable for all engine-related problems with respect to power, power measurement, technical specifications, warranty and service. Information can be found in the owner's/user handbook supplied separately by the engine manufacturer.

Troubleshooting



Danger

Injury hazard if engine is started inadvertently

Protect yourself against injury.

Before all work on this unit:

- Switch off the engine,
- Withdraw the ignition key,
- Lock the parking brake,
- Wait until all moving parts have come to a standstill; the engine must have cooled down.
- Pull off the spark plug connector so that the engine cannot inadvertently start.

Faults which occur while you are using your mower often have simple causes which you should know and may be able to rectify yourself. If you are in any doubt however, your specialist workshop will be happy to provide assistance.

Problem	Possible cause(s)	Action to take
Starter does not turn.	Safety interlock system has actuated.	To start the engine, sit on the driver's seat, fully depress brake pedal or apply parking brake. Switch off the cutters when your appliance features a PTO switch or -PTO lever. Fit a grass catcher attachment or deflector to machines with a rear discharge.
	Battery not connected correctly.	Connect red cable to (+) battery terminal and black cable to (-) battery terminal.
Starter does not turn.	Discharged or low battery.	Depending on the battery type, check the liquid level in the battery. If required, top up with distilled water up to 1 cm below the filling orifice. Then charge the battery.
	Fuse has tripped.	Replace fuse. If the fuse trips repeatedly, look for the cause (usually short-circuit).
	Loose earth cable between engine and frame.	Connect earth cable.
Starter turns but engine does not start.	Choke and throttle in wrong position.	Pull out choke. Move throttle to  .
	Carburettor not receiving any fuel, fuel tank empty.	Top up with fuel.
	Defective or dirty spark plug.	Check spark plug; see engine manual.
	No ignition spark.	Arrange for the ignition to be checked in a specialist workshop.
Engine emits smoke.	Too much oil in engine.	Switch off the mower immediately. Check engine oil level.
	Engine defective.	Switch off the mower immediately. Arrange for a specialist workshop to check the engine.
Strong vibrations.	Damaged blade shaft or defective cutter.	Switch off the mower immediately. Defective parts must be replaced by a specialist workshop.
Cutter deck does not discharge grass or cuts unevenly.	Engine speed too low.	Increase throttle.
	Travelling speed too high.	Set to a lower travelling speed.
	Cutting blade is blunt.	Arrange for a specialist workshop to sharpen or replace the blade.
Engine is running, cutter deck is not mowing.	V-belt torn.	The V-belt must be replaced in a specialist workshop.

Other ManualsLib Projects



www.manualslib.com



www.manualslib.de



www.manualslib.es



www.manualslib.fr



www.manualslib.nl



www.manualslib.mx



www.manualslib.tech 30+ Languages