

KOPPLING 3 FAS / WIRING 3 PHASE

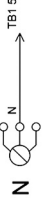

KOPPLING 1-FAS / WIRING 1-PHASE

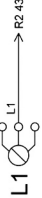
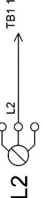
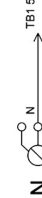
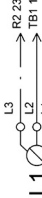

KOPPLING USA & KANADA / WIRING USA & CANADA



MASKIN KOPPLING USA-CANADA
MACHINE WIRING USA-CANADA

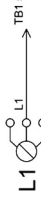
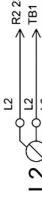

- BO BOTTOM
- MO MOTOR
- R RELAY
- ELL VARMELEMENT LAG EFFEKT
- ELH HEATER HIGH POWER
- DOOR SWITCH
- LUCKRYTARE
- AP AVLOPPSRUMP
- TB TEST BOTTEN/SWITCH
- ILA INKONTROLLAMP
- T1 THERMOSTAT (MÅN O/H)
- T3 THERMOSTAT (HÖG)
- T4 THERMOSTAT (LÅG)
- T5 THERMOSTAT
- OF ÖVERFLÖMMSBRYTARE
- REC UTTAG VATTMASKIN
- REC UTTAG VATTMASKIN
- INKB MAIN TERMINAL BLOCK
- INTERNAL ILLUMINATION
- INNERRELVYNING
- PS POWER SUPPLY
- SS STOP
- JS JIS
- App'd / Year / Week

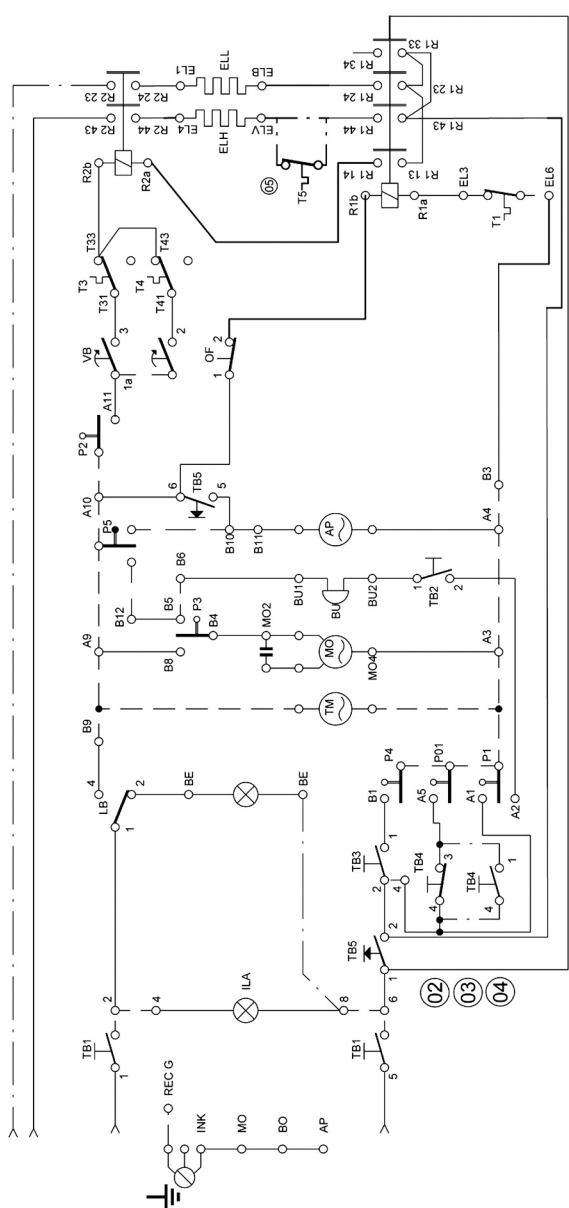

STEP NR.	START POSITION	5	10	15	20	25	30	35	40	45	50	55	60
01	COOLING 18 NEDKYLNING 18												
1	BUZZER SUMMER												
2	COOLING 9 NEDKYLNING 9												
3	HEATER RELAY ELEMENT RELAY												
4	MOTOR DIRECT MOTOR DIREKT MOTOR												
5	ANTICREASE INTERVALLGANG												
	STEP TIME STEG TID												
	BUZZER SUMMER												
	DRAIN PUMP AVLOPPSRUMP												
	BUZZER SUMMER												
	DRAIN PUMP AVLOPPSRUMP												
	BUZZER SUMMER												
	DRAIN PUMP AVLOPPSRUMP												
	BUZZER SUMMER												
	DRAIN PUMP AVLOPPSRUMP												
	BUZZER SUMMER												
	DRAIN PUMP AVLOPPSRUMP												
	BUZZER SUMMER												
	DRAIN PUMP AVLOPPSRUMP												
	BUZZER SUMMER												
	DRAIN PUMP AVLOPPSRUMP												
	BUZZER SUMMER												
	DRAIN PUMP AVLOPPSRUMP												
	BUZZER SUMMER												
	DRAIN PUMP AVLOPPSRUMP												
	BUZZER SUMMER												
	DRAIN PUMP AVLOPPSRUMP												
	BUZZER SUMMER												
	DRAIN PUMP AVLOPPSRUMP												
	BUZZER SUMMER												
	DRAIN PUMP AVLOPPSRUMP												
	BUZZER SUMMER												
	DRAIN PUMP AVLOPPSRUMP												
	BUZZER SUMMER												
	DRAIN PUMP AVLOPPSRUMP												
	BUZZER SUMMER												
	DRAIN PUMP AVLOPPSRUMP												
	BUZZER SUMMER												
	DRAIN PUMP AVLOPPSRUMP												
	BUZZER SUMMER												
	DRAIN PUMP AVLOPPSRUMP												
	BUZZER SUMMER												
	DRAIN PUMP AVLOPPSRUMP												
	BUZZER SUMMER												
	DRAIN PUMP AVLOPPSRUMP												
	BUZZER SUMMER												
	DRAIN PUMP AVLOPPSRUMP												
	BUZZER SUMMER												
	DRAIN PUMP AVLOPPSRUMP												
	BUZZER SUMMER												
	DRAIN PUMP AVLOPPSRUMP												
	BUZZER SUMMER												
	DRAIN PUMP AVLOPPSRUMP												
	BUZZER SUMMER												
	DRAIN PUMP AVLOPPSRUMP												
	BUZZER SUMMER												
	DRAIN PUMP AVLOPPSRUMP												
	BUZZER SUMMER												
	DRAIN PUMP AVLOPPSRUMP												
	BUZZER SUMMER												
	DRAIN PUMP AVLOPPSRUMP												
	BUZZER SUMMER												
	DRAIN PUMP AVLOPPSRUMP												
	BUZZER SUMMER												
	DRAIN PUMP AVLOPPSRUMP												
	BUZZER SUMMER												
	DRAIN PUMP AVLOPPSRUMP												
	BUZZER SUMMER												
	DRAIN PUMP AVLOPPSRUMP												
	BUZZER SUMMER												
	DRAIN PUMP AVLOPPSRUMP												
	BUZZER SUMMER												
	DRAIN PUMP AVLOPPSRUMP												
	BUZZER SUMMER												
	DRAIN PUMP AVLOPPSRUMP												
	BUZZER SUMMER												
	DRAIN PUMP AVLOPPSRUMP												
	BUZZER SUMMER												
	DRAIN PUMP AVLOPPSRUMP												
	BUZZER SUMMER												
	DRAIN PUMP AVLOPPSRUMP												
	BUZZER SUMMER												
	DRAIN PUMP AVLOPPSRUMP												
	BUZZER SUMMER												
	DRAIN PUMP AVLOPPSRUMP												
	BUZZER SUMMER												
	DRAIN PUMP AVLOPPSRUMP												
	BUZZER SUMMER												
	DRAIN PUMP AVLOPPSRUMP												
	BUZZER SUMMER												
	DRAIN PUMP AVLOPPSRUMP												
	BUZZER SUMMER												
	DRAIN PUMP AVLOPPSRUMP												
	BUZZER SUMMER												
	DRAIN PUMP AVLOPPSRUMP												
	BUZZER SUMMER												
	DRAIN PUMP AVLOPPSRUMP												
	BUZZER SUMMER												
	DRAIN PUMP AVLOPPSRUMP												
	BUZZER SUMMER												
	DRAIN PUMP AVLOPPSRUMP												
	BUZZER SUMMER												
	DRAIN PUMP AVLOPPSRUMP												
	BUZZER SUMMER												
	DRAIN PUMP AVLOPPSRUMP												
	BUZZER SUMMER												
	DRAIN PUMP AVLOPPSRUMP												
	BUZZER SUMMER												
	DRAIN PUMP AVLOPPSRUMP												
	BUZZER SUMMER												
	DRAIN PUMP AVLOPPSRUMP												
	BUZZER SUMMER												
	DRAIN PUMP AVLOPPSRUMP												
	BUZZER SUMMER												
	DRAIN PUMP AVLOPPSRUMP												
	BUZZER SUMMER												
	DRAIN PUMP AVLOPPSRUMP												
	BUZZER SUMMER												
	DRAIN PUMP AVLOPPSRUMP												
	BUZZER SUMMER												
	DRAIN PUMP AVLOPPSRUMP												
	BUZZER SUMMER												
	DRAIN PUMP AVLOPPSRUMP												
	BUZZER SUMMER												
	DRAIN PUMP AVLOPPSRUMP												
	BUZZER SUMMER												
	DRAIN PUMP AVLOPPSRUMP												
	BUZZER SUMMER												
	DRAIN PUMP AVLOPPSRUMP												
	BUZZER SUMMER												